

Titen HD® Heavy-Duty Screw Anchor

Titen HD Anchor Product Data — Zinc Plated

Size (in.)	Model No.	Drill Bit Dia. (in.)	Wrench Size (in.)	Quantity	
				Box	Carton
¼ x 1 7/8	THDB25178H	¼	¾	100	500
¼ x 2 ¼	THDB25234H	¼	¾	50	250
¼ x 3	THDB25300H	¼	¾	50	250
¼ x 3 ½	THDB25312H	¼	¾	50	250
¼ x 4	THDB25400H	¼	¾	50	250
¾ x 1 ¾	THD37134H†	¾	9/16	50	250
¾ x 2 ½	THD37212H†	¾	9/16	50	200
¾ x 3	THD37300H	¾	9/16	50	200
¾ x 4	THD37400H	¾	9/16	50	200
¾ x 5	THD37500H	¾	9/16	50	100
¾ x 6	THD37600H	¾	9/16	50	100
½ x 3	THD50300H	½	¾	25	100
½ x 4	THD50400H	½	¾	20	80
½ x 5	THD50500H	½	¾	20	80
½ x 6	THD50600H	½	¾	20	80
½ x 6 ½	THD50612H	½	¾	20	40
½ x 8	THD50800H	½	¾	20	40
½ x 12	THD501200H	½	¾	5	25
½ x 13	THD501300H	½	¾	5	25
½ x 14	THD501400H	½	¾	5	25
½ x 15	THD501500H	½	¾	5	25
5/8 x 4	THDB62400H	5/8	15/16	10	40
5/8 x 5	THDB62500H	5/8	15/16	10	40
5/8 x 6	THDB62600H	5/8	15/16	10	40
5/8 x 6 ½	THDB62612H	5/8	15/16	10	40
5/8 x 8	THDB62800H	5/8	15/16	10	20
5/8 x 10	THDB62100H	5/8	15/16	10	20
¾ x 4	THD75400H	¾	1 1/8	10	40
¾ x 5	THD75500H	¾	1 1/8	5	20
¾ x 6	THDT75600H	¾	1 1/8	5	20
¾ x 7	THD75700H	¾	1 1/8	5	10
¾ x 8 ½	THD75812H	¾	1 1/8	5	10
¾ x 10	THD75100H	¾	1 1/8	5	10

Titen HD Anchor Product Data — Mechanically Galvanized

Size (in.)	Model No.	Drill Bit Dia. (in.)	Wrench Size (in.)	Quantity	
				Box	Carton
¾ x 3	THD37300HMG	¾	9/16	50	200
¾ x 4	THD37400HMG			50	200
¾ x 5	THD37500HMG			50	100
¾ x 6	THD37600HMG			50	100
½ x 4	THD50400HMG	½	¾	20	80
½ x 5	THD50500HMG			20	80
½ x 6	THD50600HMG			20	80
½ x 6 ½	THD50612HMG			20	40
½ x 8	THD50800HMG			20	40
5/8 x 5	THDB62500HMG			5/8	15/16
5/8 x 6	THDB62600HMG	10	40		
5/8 x 6 ½	THDB62612HMG	10	40		
5/8 x 8	THDB62800HMG	10	20		
¾ x 6	THDT75600HMG	¾	1 1/8	5	20
¾ x 8 ½	THD75812HMG			5	10
¾ x 10	THD75100HMG			5	10

Mechanical galvanizing meets ASTM B695, Class 65, Type 1. Intended for some pressure-treated wood sill plate applications. Not for use in other corrosive or outdoor environments. See p. 248 or visit strongtie.com/info for more corrosion information.

† These models do not meet minimum embedment depth requirements for strength design and require maximum installation torque of 25 ft. - lb. using a torque wrench, driver drill or cordless ¼" impact driver with a maximum permitted torque rating of 100 ft. - lb.

Mechanical Anchors

Titen HD Installation Information and Additional Data¹



Characteristic	Symbol	Units	Nominal Anchor Diameter, d_a (in.)									
			¼	¾	½	5/8	¾					
Installation Information												
Drill Bit Diameter	d_{bit}	in.	¼	¾	½	5/8	¾					
Baseplate Clearance Hole Diameter	d_c	in.	¾	½	5/8	¾	7/8					
Maximum Installation Torque	$T_{inst,max}$	ft.-lbf	24 ²	50 ²	65 ²	100 ²	150 ²					
Maximum Impact Wrench Torque Rating	$T_{impact,max}$	ft.-lbf	125 ³	150 ³	340 ³	340 ³	385 ³					
Minimum Hole Depth	h_{hole}	in.	1 ¾	2 5/8	2 ¾	3 ½	3 ¾	4 ½	4 ½	6	6	6 ¾
Nominal Embedment Depth	h_{nom}	in.	1 5/8	2 ½	2 ½	3 ¼	3 ¼	4	4	5 ½	5 ½	6 ¼
Critical Edge Distance	c_{ac}	in.	3	6	2 1/16	3 5/8	3 9/16	4 ½	4 ½	6 3/8	6 3/8	7 5/16
Minimum Edge Distance	c_{min}	in.	1 ½		1 ¾							
Minimum Spacing	s_{min}	in.	3									
Minimum Concrete Thickness	h_{min}	in.	3 ¼	3 ½	4	5	5	6 ¼	6	8 ½	8 ¾	10
Additional Data												
Anchor Category	Category	—	1									
Yield Strength	f_{ya}	psi	100,000				97,000					
Tensile Strength	f_{uta}	psi	125,000				110,000					
Minimum Tensile and Shear Stress Area	A_{se}	in ²	0.042		0.099		0.183		0.276		0.414	
Axial Stiffness in Service Load Range – Uncracked Concrete	β_{unscr}	lb./in.	202,000				715,000					
Axial Stiffness in Service Load Range – Cracked Concrete	β_{cr}	lb./in.	173,000				345,000					

- The information presented in this table is to be used in conjunction with the design criteria of ACI 318-14 Chapter 17 and ACI 318 Appendix D.
- $T_{inst,max}$ is the maximum permitted installation torque for the embedment depth range covered by this table using a torque wrench.
- $T_{impact,max}$ is the maximum permitted torque rating for impact wrenches for the embedment depth range covered by this table.

* See p. 13 for an explanation of the load table icons.

Titen HD® Design Information — Concrete



Titen HD Tension Strength Design Data¹

Characteristic	Symbol	Units	Nominal Anchor Diameter, d _a (in.)									
			¼		⅜		½		⅝		¾	
Nominal Embedment Depth	<i>h_{nom}</i>	in.	1⅝	2½	2½	3¼	3¼	4	4	5½	5½	6¼
Steel Strength in Tension												
Tension Resistance of Steel	<i>N_{sa}</i>	lb.	5,195		10,890		20,130		30,360		45,540	
Strength Reduction Factor — Steel Failure	<i>φ_{sa}</i>	—	0.65 ²									
Concrete Breakout Strength in Tension^{6,8}												
Effective Embedment Depth	<i>h_{ef}</i>	in.	1.19	1.94	1.77	2.40	2.35	2.99	2.97	4.24	4.22	4.86
Critical Edge Distance ⁶	<i>c_{ac}</i>	in.	3	6	2 ¹¹ / ₁₆	3⅝	3 ⁹ / ₁₆	4½	4½	6⅝	6⅝	7 ⁵ / ₁₆
Effectiveness Factor — Uncracked Concrete	<i>k_{uncr}</i>	—	30		24							
Effectiveness Factor — Cracked Concrete	<i>k_{cr}</i>	—	17									
Modification Factor	<i>ψ_{c,N}</i>	—	1.0									
Strength Reduction Factor — Concrete Breakout Failure	<i>φ_{cb}</i>	—	0.65 ⁷									
Pullout Strength in Tension⁸												
Pullout Resistance, Uncracked Concrete (<i>f'_c</i> = 2,500 psi)	<i>N_{p,uncr}</i>	lb.	— ³	— ³	2,700 ⁴	— ³	— ³	— ³	— ³	9,810 ⁴	— ³	— ³
Pullout Resistance, Cracked Concrete (<i>f'_c</i> = 2,500 psi)	<i>N_{p,cr}</i>	lb.	— ³	1,905 ⁴	1,235 ⁴	2,700 ⁴	— ³	— ³	3,040 ⁴	5,570 ⁴	6,070 ⁴	7,195 ⁴
Strength Reduction Factor — Concrete Pullout Failure	<i>φ_p</i>	—	0.65 ⁵									
Breakout or Pullout Strength in Tension for Seismic Applications⁸												
Nominal Pullout Strength for Seismic Loads (<i>f'_c</i> = 2,500 psi)	<i>N_{p,eq}</i>	lb.	— ³	1,905 ⁴	1,235 ⁴	2,700 ⁴	— ³	— ³	3,040 ⁴	5,570 ⁴	6,070 ⁴	7,195 ⁴
Strength Reduction Factor — Breakout or Pullout Failure	<i>φ_{eq}</i>	—	0.65 ⁵									

- The information presented in this table is to be used in conjunction with the design criteria of ACI 318-14 Chapter 17 and ACI 318-11 Appendix D, except as modified below.
- The tabulated value of *φ_{sa}* applies when the load combinations of Section 1605.2.1 of the IBC, ACI 318-14 Section 5.3 or ACI 318-11 Section 9.2 are used. If the load combinations of ACI 318-11 Appendix C are used, the appropriate value of *φ_{sa}* must be determined in accordance with ACI 318-11 D.4.4. Anchors are considered brittle steel elements.
- Pullout strength is not reported since concrete breakout controls.
- Adjust the characteristic pullout resistance for other concrete compressive strengths by multiplying the tabular value by (*f'_{c,specified}* / 2,500)^{0.5}.
- The tabulated value of *φ_p* or *φ_{eq}* applies when the load combinations of Section 1605.2.1 of the IBC, ACI 318-14 Section 5.3 or ACI 318-11 Section 9.2 are used and the requirements of ACI 318-14 17.3.3(c) or ACI 318-11 D.4.3(c) for Condition B are met. If the load combinations of ACI 318-11 Appendix C are used, appropriate value of *φ* must be determined in accordance with ACI 318-11 Section D.4.4(c).
- The modification factor *ψ_{cp,N}* = 1.0 for cracked concrete. Otherwise, the modification factor for uncracked concrete without supplementary reinforcement to control splitting is either:
 (1) *ψ_{cp,N}* = 1.0 if *c_{a,min}* ≥ *c_{ac}* or (2) *ψ_{cp,N}* = $\frac{c_{a,min}}{c_{ac}} \geq \frac{1.5h_{ef}}{c_{ac}}$ if *c_{a,min}* < *c_{ac}*
 The modification factor, *ψ_{cp,N}* is applied to the nominal concrete breakout strength, *N_{cb}* or *N_{cbg}*.
- The tabulated value of *φ_{cb}* applies when both the load combinations of Section 1605.2.1 of the IBC, ACI 318-14 Section 5.3 or ACI 318-11 Section 9.2 are used and the requirements of ACI 318-14 17.3.3(c) or ACI 318-11 D.4.3(c) for Condition B are met. Condition B applies where supplementary reinforcement is not provided. For installations where complying supplementary reinforcement can be verified, the *φ_{cb}* factors described in ACI 318-14 17.3.3(c) or ACI 318-11 D.4.3(c) for Condition A are allowed. If the load combinations of ACI 318-11 Appendix C are used, the appropriate value of *φ_{cb}* must be determined in accordance with ACI 318-11 D.4.4(c).

C-A-2018 © 2018 SIMPSON STRONG-TIE COMPANY, INC.

Mechanical Anchors

* See p. 13 for an explanation of the load table icons.

Titen HD® Design Information — Concrete

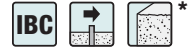

Mechanical Anchors

Titen HD Shear Strength Design Data¹

Characteristic	Symbol	Units	Nominal Anchor Diameter, d_a (in.)										
			1/4 ⁵		3/8		1/2		5/8 ⁵		3/4		
Nominal Embedment Depth	h_{nom}	in.	1 3/8	2 1/2	2 1/2	3 1/4	3 1/4	4	4	5 1/2	5 1/2	6 1/4	
Steel Strength in Shear													
Shear Resistance of Steel	V_{sa}	lb.	2,020		4,460		7,455		10,000		16,840		
Strength Reduction Factor — Steel Failure	ϕ_{sa}	—	0.60 ²										
Concrete Breakout Strength in Shear⁶													
Outside Diameter	d_a	in.	0.25		0.375		0.500		0.625		0.750		
Load Bearing Length of Anchor in Shear	ℓ_e	in.	1.19	1.94	1.77	2.40	2.35	2.99	2.97	4.24	4.22	4.86	
Strength Reduction Factor — Concrete Breakout Failure	ϕ_{cb}	—	0.70 ⁴										
Concrete Pryout Strength in Shear													
Coefficient for Pryout Strength	k_{cp}	lb.	1.0					2.0					
Strength Reduction Factor — Concrete Pryout Failure	ϕ_{cp}	—	0.70 ⁴										
Steel Strength in Shear for Seismic Applications													
Shear Resistance for Seismic Loads	V_{eq}	lb.	1,695		2,855		4,790		8,000		9,350		
Strength Reduction Factor — Steel Failure	ϕ_{eq}	—	0.60 ²										

- The information presented in this table is to be used in conjunction with the design criteria of ACI 318-14 Chapter 17 and ACI 318-11 Appendix D, except as modified below.
- The tabulated value of ϕ_{sa} applies when the load combinations of Section 1605.2.1 of the IBC, ACI 318-14 Section 5.3 or ACI 318-11 Section 9.2 are used. If the load combinations of ACI 318-11 Appendix C are used, the appropriate value of ϕ_{sa} must be determined in accordance with ACI 318 D.4.4.
- The tabulated value of ϕ_{cb} applies when both the load combinations of Section 1605.2.1 of the IBC, ACI 318-14 Section 5.3 or ACI 318-11 Section 9.2 are used and the requirements of ACI 318-14 17.3.3(c) or ACI 318-11 D.4.3(c) for Condition B are met. Condition B applies where

- supplementary reinforcement is not provided. For installations where complying supplementary reinforcement can be verified, the ϕ_{cb} factors described in ACI 318-14 17.3.3(c) or ACI 318-11 D.4.3(c) for Condition A are allowed. If the load combinations of ACI 318-11 Appendix C are used, the appropriate value of ϕ_{cb} must be determined in accordance with ACI 318-11 D.4.4(c).
- The tabulated value of ϕ_{cp} applies when both the load combinations of IBC Section 1605.2, ACI 318-14 5.3 or ACI 318-11 Section 9.2 are used and the requirements of ACI 318-14 17.3.3(c) or ACI 318-11 D.4.3(c) for Condition B are met. If the load combinations of ACI 318-11 Appendix C are used, appropriate value of ϕ_{cp} must be determined in accordance with ACI 318-11 Section D.4.4(c).

Titen HD Tension and Shear Strength Design Data for the Soffit of Normal-Weight or Sand-Lightweight Concrete over Metal Deck^{1,6,8}



Characteristic	Symbol	Units	Nominal Anchor Diameter, d_a (in.)									
			Lower Flute						Upper Flute			
			Figure 2		Figure 1		Figure 1		Figure 2		Figure 1	
			1/4 ⁸		3/8		1/2		1/4 ⁸		3/8	
Nominal Embedment Depth	h_{nom}	in.	1 3/8	2 1/2	1 7/8	2 1/2	2	3 1/2	1 3/8	2 1/2	1 7/8	2
Effective Embedment Depth	h_{ef}	in.	1.19	1.94	1.23	1.77	1.29	2.56	1.19	1.94	1.23	1.29
Pullout Resistance, concrete on metal deck (cracked) ^{2,3,4}	$N_{p,deck,cr}$	lb.	420	535	375	870	905	2,040	655	1,195	500	1,700
Pullout Resistance, concrete on metal deck (uncracked) ^{2,3,4}	$N_{p,deck,uncr}$	lb.	995	1,275	825	1,905	1,295	2,910	1,555	2,850	1,095	2,430
Steel Strength in Shear, concrete on metal deck ⁵	$V_{sa,deck}$	lb.	1,335	1,745	2,240	2,395	2,435	4,430	2,010	2,420	4,180	7,145
Steel Strength in Shear, Seismic	$V_{sa,deck,eq}$	lb.	870	1,135	1,434	1,533	1,565	2,846	1,305	1,575	2,676	4,591

- The information presented in this table is to be used in conjunction with the design criteria of ACI 318-14 Chapter 17 and ACI 318-11 Appendix D, except as modified below.
- Concrete compressive strength shall be 3,000 psi minimum. The characteristic pullout resistance for greater compressive strengths shall be increased by multiplying the tabular value by $(f'_{c,specified} / 3,000)^{0.5}$.
- For anchors installed in the soffit of sand-lightweight or normal-weight concrete over metal deck floor and roof assemblies, as shown in Figure 1 and Figure 2, calculation of the concrete breakout strength may be omitted.
- In accordance with ACI 318-14 Section 17.4.3.2 or ACI 318-11 Section D.5.3.2, the nominal pullout strength in cracked concrete for anchors

- installed in the soffit of sand-lightweight or normal-weight concrete over metal deck floor and roof assemblies $N_{p,deck,cr}$ shall be substituted for $N_{p,cr}$. Where analysis indicates no cracking at service loads, the normal pullout strength in uncracked concrete $N_{p,deck,uncr}$ shall be substituted for $N_{p,uncr}$.
- In accordance with ACI 318-14 Section 17.5.1.2(C) or ACI 318-11 Section D.6.1.2(c), the shear strength for anchors installed in the soffit of sand-lightweight or normal-weight concrete over metal deck floor and roof assemblies $V_{sa,deck}$ and $V_{sa,deck,eq}$ shall be substituted for V_{sa} .
 - Minimum edge distance to edge of panel is $2h_{ef}$.
 - The minimum anchor spacing along the flute must be the greater of $3h_{ef}$ or 1.5 times the flute width.

* See p. 13 for an explanation of the load table icons.

Titen HD® Design Information — Concrete

Titen HD Anchor Tension and Shear Strength Design
Data in the Topside of Normal-Weight Concrete or
Sand-Lightweight Concrete over Metal Deck

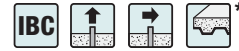

Design Information	Symbol	Units	Nominal Anchor Diameter, d_a (in.)	
			Figure 3	Figure 3
			1/4	3/8
Nominal Embedment Depth	h_{nom}	in.	1 5/8	2 1/2
Effective Embedment Depth	h_{ef}	in.	1.19	1.77
Minimum Concrete Thickness	$h_{min,deck}$	in.	2 1/2	3 1/4
Critical Edge Distance	$c_{ac,deck,top}$	in.	3 3/4	7 1/4
Minimum Edge Distance	$c_{min,deck,top}$	in.	3 1/2	3
Minimum Spacing	$s_{min,deck,top}$	in.	3 1/2	3

- For anchors installed in the topside of concrete-filled deck assemblies, as shown in Figures 2 and 3, the nominal concrete breakout strength of a single anchor or group of anchors in shear, V_{cb} or V_{cbg} , respectively, must be calculated in accordance with ACI 318-14 Section 17.5.2 or ACI 318-11 Section D.6.2, using the actual member thickness, $h_{min,deck}$, in the determination of A_{vc} .
- Design capacity shall be based on calculations according to values in the tables featured on pp. 116–118.
- Minimum flute depth (distance from top of flute to bottom of flute) is 1 1/2" (see Figures 2 and 3).
- Steel deck thickness shall be minimum 20 gauge.
- Minimum concrete thickness ($h_{min,deck}$) refers to concrete thickness above upper flute (see Figures 2 and 3).

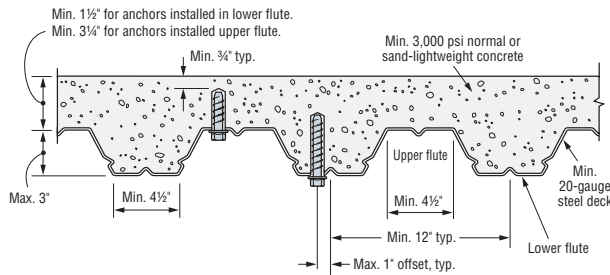

Figure 1. Installation of 3/8"- and 1/2"-Diameter Anchors in the Soffit of Concrete over Metal Deck

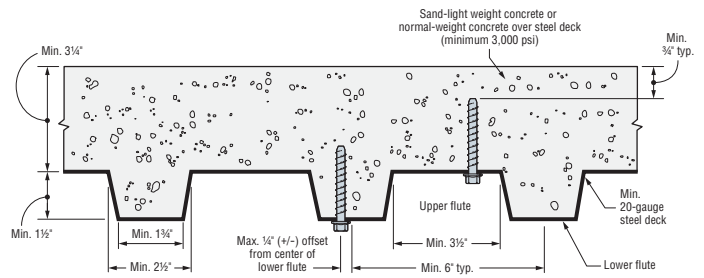

Figure 2. Installation of 1/4"-Diameter Anchors in the Soffit of Concrete over Metal Deck

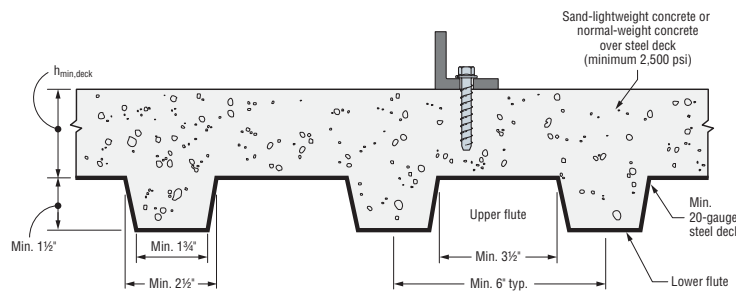

Figure 3. Installation of 1/4"- and 3/8"-Diameter Anchors in the Topside of Concrete over Metal Deck

C-A-2018 © 2018 SIMPSON STRONG-TIE COMPANY INC.

* See p. 13 for an explanation of the load table icons.

Titen HD® Design Information — Masonry

Titen HD Allowable Tension and Shear Loads
in 8" Lightweight, Medium-Weight and
Normal-Weight Grout-Filled CMU

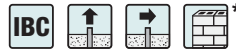

Size in. (mm)	Drill Bit Dia. in.	Min. Embed. Depth in. (mm)	Critical Edge Dist. in. (mm)	Critical End Dist. in. (mm)	Critical Spacing Dist. in. (mm)	Values for 8" Lightweight, Medium-Weight or Normal-Weight Grout-Filled CMU			
						Tension Load		Shear Load	
						Ultimate lb. (kN)	Allowable lb. (kN)	Ultimate lb. (kN)	Allowable lb. (kN)
Anchor Installed in the Face of the CMU Wall (See Figure 4)									
3/8 (9.5)	3/8	2 3/4 (70)	12 (305)	12 (305)	6 (152)	2,390 (10.6)	480 (2.1)	4,340 (19.3)	870 (3.9)
1/2 (12.7)	1/2	3 1/2 (89)	12 (305)	12 (305)	8 (203)	3,440 (15.3)	690 (3.1)	6,920 (30.8)	1,385 (6.2)
5/8 (15.9)	5/8	4 1/2 (114)	12 (305)	12 (305)	10 (254)	5,300 (23.6)	1,060 (4.7)	10,420 (46.4)	2,085 (9.3)
3/4 (19.1)	3/4	5 1/2 (140)	12 (305)	12 (305)	12 (305)	7,990 (35.5)	1,600 (7.1)	15,000 (66.7)	3,000 (13.3)

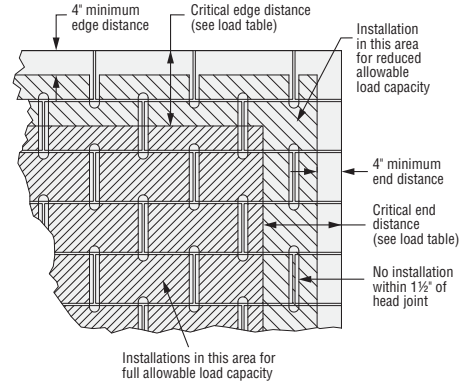

Figure 4. Shaded Area = Placement for Full and Reduced Allowable Load Capacity in Grout-Filled CMU

1. The tabulated allowable loads are based on a safety factor of 5.0 for installations under the IBC and IRC.
2. Values for 8"-wide, lightweight, medium-weight and normal-weight concrete masonry units.
3. The masonry units must be fully grouted.
4. The minimum specified compressive strength of masonry, f'_m , at 28 days is 1,500 psi.
5. Embedment depth is measured from the outside face of the concrete masonry unit.
6. Allowable loads may be increased 33 1/3% for short-term loading due to wind or seismic forces where permitted by code.
7. Grout-filled CMU wall design must satisfy applicable design standards and be capable of withstanding applied loads.
8. Refer to allowable load-adjustment factors for spacing and edge distance on p. 123.

Mechanical Anchors

Titen HD Allowable Tension and Shear Loads
in 8" Lightweight, Medium-Weight and
Normal-Weight Hollow CMU



Size in. (mm)	Drill Bit Dia. in.	Embed. Depth ¹ in. (mm)	Min. Edge Dist. in. (mm)	Min. End Dist. in. (mm)	8" Hollow CMU Loads Based on CMU Strength			
					Tension Load		Shear Load	
					Ultimate lb. (kN)	Allowable lb. (kN)	Ultimate lb. (kN)	Allowable lb. (kN)
Anchor Installed in Face Shell (See Figure 5)								
3/8 (9.5)	3/8	1 3/4 (45)	4 (102)	4 5/8 (117)	720 (3.2)	145 (0.6)	1,240 (5.5)	250 (1.1)
1/2 (12.7)	1/2	1 3/4 (45)	4 (102)	4 5/8 (117)	760 (3.4)	150 (0.7)	1,240 (5.5)	250 (1.1)
5/8 (15.9)	5/8	1 3/4 (45)	4 (102)	4 5/8 (117)	800 (3.6)	160 (0.7)	1,240 (5.5)	250 (1.1)
3/4 (19.1)	3/4	1 3/4 (45)	4 (102)	4 5/8 (117)	880 (3.9)	175 (0.8)	1,240 (5.5)	250 (1.1)

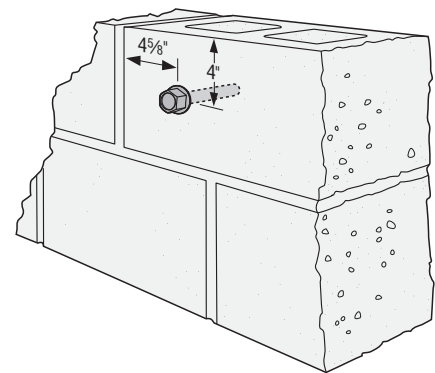

Figure 5

1. The tabulated allowable loads are based on a safety factor of 5.0 for installations under the IBC and IRC.
2. Values for 8"-wide, lightweight, medium-weight and normal-weight concrete masonry units.
3. The minimum specified compressive strength of masonry, f'_m , at 28 days is 1,500 psi.
4. Embedment depth is measured from the outside face of the concrete masonry unit and is based on the anchor being embedded an additional 1/2"- through 1 1/4"-thick face shell.
5. Allowable loads may not be increased for short-term loading due to wind or seismic forces. CMU wall design must satisfy applicable design standards and be capable of withstanding applied loads.
6. Do not use impact wrenches to install in hollow CMU.
7. Set drill to rotation-only mode when drilling into hollow CMU.

* See p. 13 for an explanation of the load table icons.

Titen HD® Design Information — Masonry

Titen HD® Allowable Tension and Shear Loads in 8" Lightweight, Medium-Weight and Normal-Weight Grout-Filled CMU Stemwall

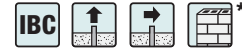

Size in. (mm)	Drill Bit Dia. in.	Embed. Depth in. (mm)	Min. Edge Dist. in. (mm)	Min. End Dist. in. (mm)	Critical Spacing Dist. in. (mm)	8" Grout-Filled CMU Allowable Loads Based on CMU Strength					
						Tension		Shear Perp. to Edge		Shear Parallel to Edge	
						Ultimate lb. (kN)	Allowable lb. (kN)	Ultimate lb. (kN)	Allowable lb. (kN)	Ultimate lb. (kN)	Allowable lb. (kN)
Anchor Installed in Cell Opening or Web (Top of Wall) (See Figure 6)											
1/2 (12.7)	1/2	4 1/2 (114)	1 3/4 (45)	8 (203)	8 (203)	2,860 (12.7)	570 (2.5)	800 (3.6)	160 (0.7)	2,920 (13.0)	585 (2.6)
5/8 (15.9)	5/8	4 1/2 (114)	1 3/4 (45)	10 (254)	10 (254)	2,860 (12.7)	570 (2.5)	800 (3.6)	160 (0.7)	3,380 (15.0)	675 (3.0)

1. The tabulated allowable loads are based on a safety factor of 5.0 for installations under the IBC and IRC.
2. Values are for 8"-wide, lightweight, medium-weight and normal-weight concrete masonry units.
3. The masonry units must be fully grouted.
4. The minimum specified compressive strength of masonry, f'_m , at 28 days is 1,500 psi.
5. Allowable loads may be increased 33 1/3% for short-term loading due to wind or seismic forces where permitted by code.
6. Grout-filled CMU wall design must satisfy applicable design standards and be capable of withstanding applied design loads.
7. Loads are based on anchor installed in either the web or grout-filled cell opening in the top of wall.

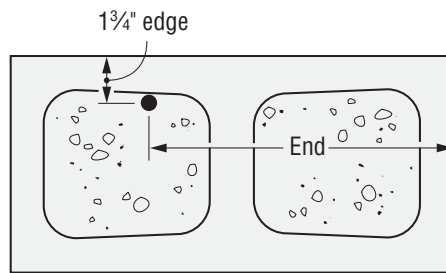

Figure 6. Anchor Installed in Top of Wall

* See p. 13 for an explanation of the load table icons.

Titen HD® Design Information — Masonry

Titen HD Allowable Tension Loads for 8" Lightweight, Medium-Weight and Normal-Weight CMU Chair Blocks Filled with Normal-Weight Concrete



Size in. (mm)	Drill Bit Dia. (in.)	Min. Embed. Depth in. (mm)	Min. Edge Dist. in. (mm)	Critical Spacing in. (mm)	8" Concrete-Filled CMU Chair Block Allowable Tension Loads Based on CMU Strength	
					Ultimate lb. (kN)	Allowable lb. (kN)
3/8 (9.5)	3/8	2 3/8 (60)	1 3/4 (44)	9 1/2 (241)	3,175 (14.1)	635 (2.8)
		3 3/8 (86)	1 3/4 (44)	13 1/2 (343)	5,175 (23.0)	1,035 (4.6)
		5 (127)	2 1/4 (57)	20 (508)	10,584 (47.1)	2,115 (9.4)
1/2 (12.7)	1/2	8 (203)	2 1/4 (57)	32 (813)	13,722 (61.0)	2,754 (12.2)
		10 (254)	2 1/4 (57)	40 (1016)	16,630 (74.0)	3,325 (14.8)
5/8 (15.9)	5/8	5 1/2 (140)	1 3/4 (44)	22 (559)	9,025 (40.1)	1,805 (8.1)

1. The tabulated allowable loads are based on a safety factor of 5.0.
2. Values are for 8"-wide concrete masonry units (CMU) filled with concrete, with minimum compressive strength of 2,500 psi and poured monolithically with the floor slab.
3. Center #5 rebar in CMU cell and concrete slab as shown in the illustration below.

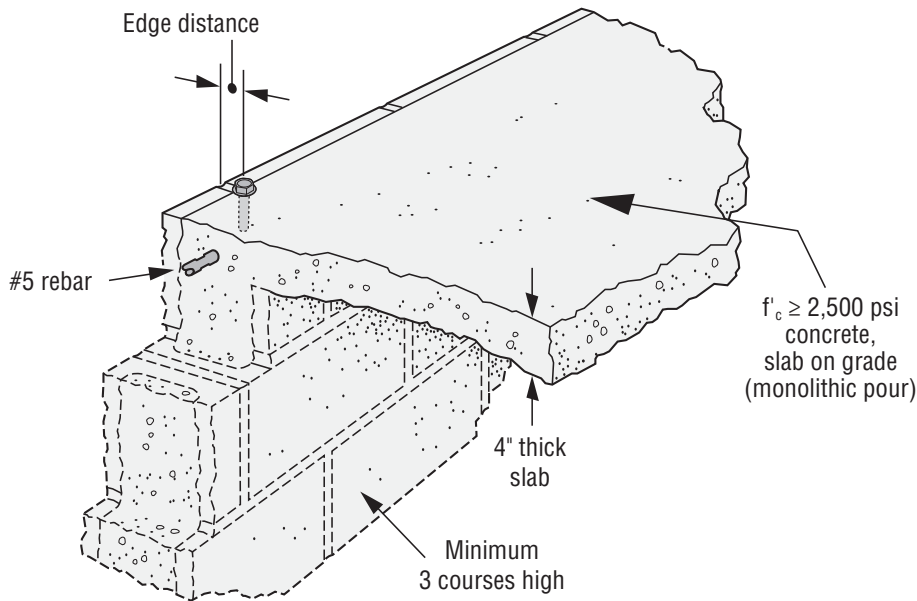

* See p. 13 for an explanation of the load table icons.

Titen HD® Design Information — Masonry

Load-Adjustment Factors for Titen HD Anchors in Face-of-Wall Installation in 8" Grout-Filled CMU: Edge Distance and Spacing, Tension and Shear Loads

How to use these charts:

1. The following tables are for reduced edge distance and spacing.
2. Locate the anchor size to be used for either a tension and/or shear load application.
3. Locate the embedment (E) at which the anchor is to be installed.
4. Locate the edge distance (c_{act}) or spacing (s_{act}) at which the anchor is to be installed.
5. The load adjustment factor (f_c or f_s) is the intersection of the row and column.
6. Multiply the allowable load by the applicable load adjustment factor.
7. Reduction factors for multiple edges or spacings are multiplied together.

Edge or End Distance Tension (f_c)

c_{act} (in.)	Dia.	3/8	1/2	5/8	3/4
	E	2 3/4	3 1/2	4 1/2	5 1/2
	c_{cr}	12	12	12	12
	c_{min}	4	4	4	4
	f_{cmin}	1.00	1.00	0.83	0.66
4		1.00	1.00	0.83	0.66
6		1.00	1.00	0.87	0.75
8		1.00	1.00	0.92	0.83
10		1.00	1.00	0.96	0.92
12		1.00	1.00	1.00	1.00

See notes below.

Edge or End Distance Shear (f_c) Shear Load Perpendicular to Edge or End (Directed Towards Edge or End)

c_{act} (in.)	Dia.	3/8	1/2	5/8	3/4
	E	2 3/4	3 1/2	4 1/2	5 1/2
	c_{cr}	12	12	12	12
	c_{min}	4	4	4	4
	f_{cmin}	0.58	0.38	0.30	0.21
4		0.58	0.38	0.30	0.21
6		0.69	0.54	0.48	0.41
8		0.79	0.69	0.65	0.61
10		0.90	0.85	0.83	0.80
12		1.00	1.00	1.00	1.00

1. E = Embedment depth (inches).
2. c_{act} = actual end or edge distance at which anchor is installed (inches).
3. c_{cr} = critical end or edge distance for 100% load (inches).
4. c_{min} = minimum end or edge distance for reduced load (inches).
5. f_c = adjustment factor for allowable load at actual end or edge distance.
6. f_{ccr} = adjustment factor for allowable load at critical end or edge distance. f_{ccr} is always = 1.00.
7. f_{cmin} = adjustment factor for allowable load at minimum end or edge distance.
8. $f_c = f_{cmin} + [(1 - f_{cmin})(c_{act} - c_{min}) / (c_{cr} - c_{min})]$.

Spacing Tension (f_s)

s_{act} (in.)	Dia.	3/8	1/2	5/8	3/4
	E	2 3/4	3 1/2	4 1/2	5 1/2
	s_{cr}	6	8	10	12
	s_{min}	3	4	5	6
	f_{smin}	0.87	0.69	0.59	0.50
3		0.87			
4		0.91	0.69		
5		0.96	0.77	0.59	
6		1.00	0.85	0.67	0.50
8			1.00	0.84	0.67
10				1.00	0.83
12					1.00

1. E = Embedment depth (inches).
2. s_{act} = actual spacing distance at which anchors are installed (inches).
3. s_{cr} = critical spacing distance for 100% load (inches).
4. s_{min} = minimum spacing distance for reduced load (inches).
5. f_s = adjustment factor for allowable load at actual spacing distance.
6. f_{scr} = adjustment factor for allowable load at critical spacing distance. f_{scr} is always = 1.00.
7. f_{smin} = adjustment factor for allowable load at minimum spacing distance.
8. $f_s = f_{smin} + [(1 - f_{smin})(s_{act} - s_{min}) / (s_{cr} - s_{min})]$.

* See p. 13 for an explanation of the load table icons.

Edge or End Distance Shear (f_c) Shear Load Parallel to Edge or End

c_{act} (in.)	Dia.	3/8	1/2	5/8	3/4
	E	2 3/4	3 1/2	4 1/2	5 1/2
	c_{cr}	12	12	12	12
	c_{min}	4	4	4	4
	f_{cmin}	0.77	0.48	0.46	0.44
4		0.77	0.48	0.46	0.44
6		0.83	0.61	0.60	0.58
8		0.89	0.74	0.73	0.72
10		0.94	0.87	0.87	0.86
12		1.00	1.00	1.00	1.00

See notes below.

Edge or End Distance Shear (f_c) Shear Load Perpendicular to Edge or End (Directed Away From Edge or End)

c_{act} (in.)	Dia.	3/8	1/2	5/8	3/4
	E	2 3/4	3 1/2	4 1/2	5 1/2
	c_{cr}	12	12	12	12
	c_{min}	4	4	4	4
	f_{cmin}	0.89	0.79	0.58	0.38
4		0.89	0.79	0.58	0.38
6		0.92	0.84	0.69	0.54
8		0.95	0.90	0.79	0.69
10		0.97	0.95	0.90	0.85
12		1.00	1.00	1.00	1.00

Spacing Shear (f_s)

s_{act} (in.)	Dia.	3/8	1/2	5/8	3/4
	E	2 3/4	3 1/2	4 1/2	5 1/2
	s_{cr}	6	8	10	12
	s_{min}	3	4	5	6
	f_{smin}	0.62	0.62	0.62	0.62
3		0.62			
4		0.75	0.62		
5		0.87	0.72	0.62	
6		1.00	0.81	0.70	0.62
8			1.00	0.85	0.75
10				1.00	0.87
12					1.00

C-A-2018 © 2018 SIMPSON STRONG-TIE COMPANY, INC.

Mechanical Anchors